

# LM4982 Boomer® Audio Power Amplifier Series

## Ground-Referenced, Ultra Low Noise, 80mW Stereo Headphone Amplifier with IntelliSense and I2C Volume Control

### General Description

The LM4982 is a ground referenced, variable gain audio power amplifier capable of delivering 80mW of continuous average power into a 16Ω single-ended load with less than 1% THD+N from a 3V power supply. The I<sup>2</sup>C volume control allows +18 to -76 dB gain settings.

The LM4982 utilizes advanced charge pump technology to generate the LM4982's negative supply voltage. This eliminates the need for output-coupling capacitors typically used with single-ended loads.

IntelliSense is a new circuit technology that allows the LM4982 to detect whether a mono or stereo headphone plug has been inserted into the output jack.

Boomer audio power amplifiers were designed specifically to provide high quality output power with a minimal amount of external components. The LM4982 does not require output coupling capacitors or bootstrap capacitors, and therefore is ideally suited for mobile phone and other low voltage applications where minimal power consumption is a primary requirement.

The LM4982 incorporates selectable low-power consumption shutdown and channel select modes.

The LM4982 contains advanced pop & click circuitry that eliminates noises which would otherwise occur during turn-on and turn-off transitions.

### Key Specifications

- Improved PSRR at 217Hz 66dB
- Stereo Output Power at  $V_{DD} = 3V$ ,  
 $R_L = 32\Omega$ , THD+N = 1% 51mW (typ)
- Shutdown current 0.1μA (typ)

### Features

- Ground referenced outputs
- I<sup>2</sup>C Volume and mode controls
- Available in space-saving micro SMD package
- Ultra low current shutdown mode
- Advanced pop & click circuitry eliminates noises during turn-on and turn-off transitions
- 1.6 – 4.0V operation
- No output coupling capacitors, snubber networks, bootstrap capacitors or gain-setting resistors required
- Mono/Stereo headphone detect

### Applications

- Notebook PCs
- Desktop PCs
- Mobile Phones
- PDAs
- Portable electronic devices
- MP3 Players

# Typical Application

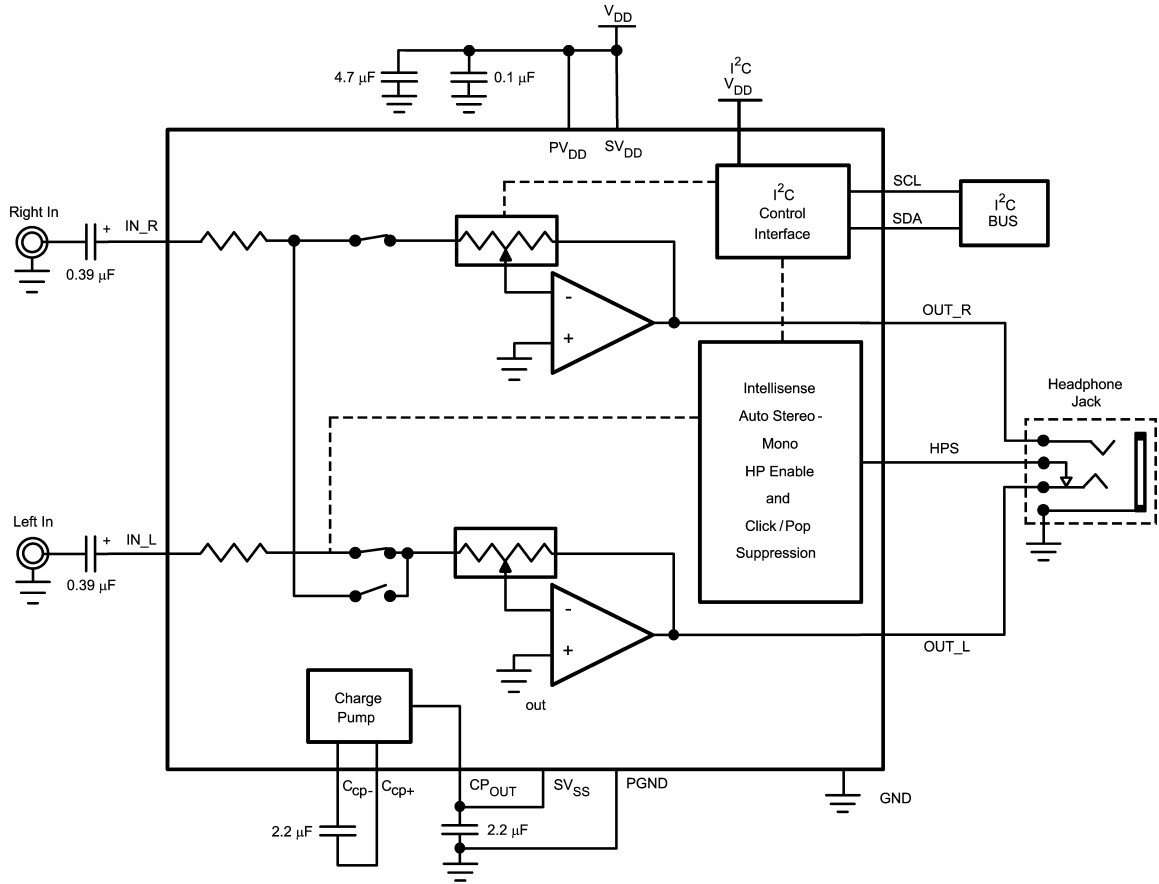

20161466

FIGURE 1. Typical Audio Amplifier Application Circuit

## Connection Diagrams

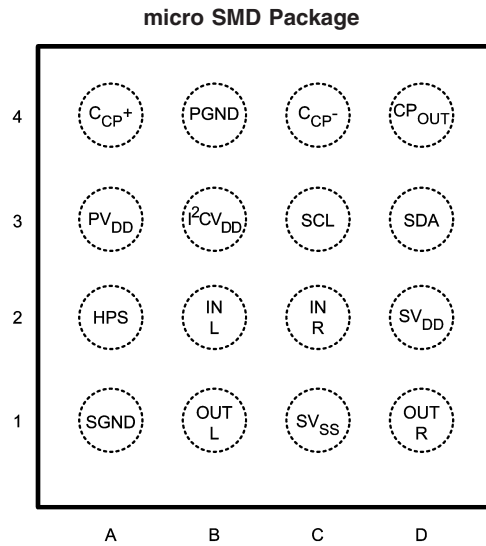

Top View  
Order Number LM4982TL

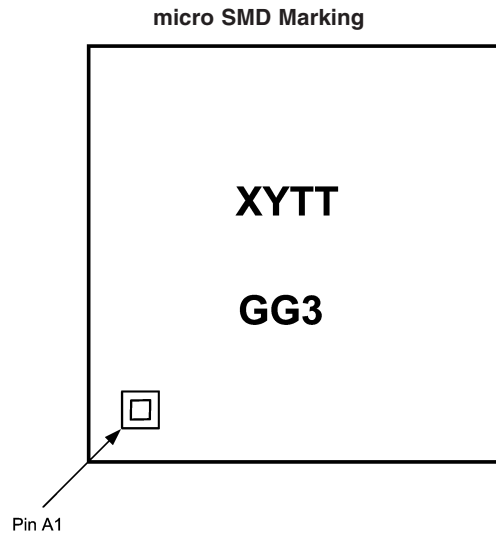

Top View  
XY - Date Code  
TT - Lot Traceability  
GG3 - LM4982  
See NS Package Number LM4982TL

### Pin Descriptions

Pin Designator	Pin Name	Pin Function
A1	SGND	Amplifier ground
A2	HPE	Headphone sende input
A3	PV <sub>DD</sub>	Charge pump / digital power supply
A4	C <sub>CP+</sub>	Charge pump fly capacitor positive side
B1	OUT_L	Left channel output
B2	IN_L	Left channel input
B3	I <sup>2</sup> C_V <sub>DD</sub>	I <sup>2</sup> C power supply
B4	PGND	Charge pump / digital ground
C1	SV <sub>SS</sub>	Amplifier negative supply
C2	IN_R	Right channel input
C3	SCL	I <sup>2</sup> C SCL line
C4	C <sub>CP-</sub>	Charge pump fly capacitor negative side
D1	OUT_R	Right channel output
D2	SV <sub>DD</sub>	Amplifier positive supply
D3	SDA	I <sup>2</sup> C SDA line
D4	CP <sub>OUT</sub>	Charge pump power output

**Absolute Maximum Ratings** (Note 2)

If Military/Aerospace specified devices are required, please contact the National Semiconductor Sales Office/Distributors for availability and specifications.

Supply Voltage	4.5V
Storage Temperature	-65°C to +150°C
Input Voltage	-0.3V to $V_{DD} + 0.3V$
Power Dissipation (Note 3)	Internally Limited
ESD Susceptibility (Note 4)	2000V
ESD Susceptibility (Note 5)	200V

Junction Temperature	150°C
Thermal Resistance	
$\theta_{JA}$ (typ) - (TLA16XXX)	105°C/W (Note X)

**Operating Ratings**

Temperature Range	
$T_{MIN} \leq T_A \leq T_{MAX}$	-40°C $\leq$ $T_A$ $\leq$ +85°C
Supply Voltage	1.6V $\leq$ $V_{DD}$ $\leq$ 4.0V

**Audio Amplifier Electrical Characteristics  $V_{DD} = 3V$**  (Notes 1, 2)

The following specifications apply for  $V_{DD} = 3V$ ,  $R_L = 16\Omega$ ,  $A_V = 0dB$ , unless otherwise specified. Limits apply for  $T_A = 25^\circ C$ .

Symbol	Parameter	Conditions	LM4982		Units (Limits)
			Typical (Note 6)	Limits (Notes 7, 8)	
$I_{DD}$	Quiescent Power Supply Current Full Power Mode	$V_{IN} = 0V$ , inputs terminated, both channels enabled	8.1	11.5	mA (max)
		$V_{IN} = 0V$ , inputs terminated, one channel enabled	5.1	7.3	mA
		$V_{IN} = 0V$ , inputs terminated, No headphone inserted	2.15		mA
$I_{SD}$	Shutdown Current	With SD enabled	0.1	1.5	$\mu A$ (max)
$V_{OS}$	Output Offset Voltage	$R_L = 32\Omega$	0.7	4.5	mV (max)
$A_V$	Gain Max and Min settings	[B0:B4] = 00000	-70		dB
		[B0:B4] = 11111	+18		dB
$R_{IN}$	Input Resistance	gain setting 18dB	22	15 29	k $\Omega$ (min) k $\Omega$ (max)
		gain setting -76dB	200		k $\Omega$
$P_{OUT}$	Stereo Output Power	THD+N = 1% (max); f = 1kHz, $R_L = 16\Omega$ , per channel	47	40	mW (min)
		THD+N = 1% (max); f = 1kHz, $R_L = 32\Omega$ , per channel	51		mW
THD+N	Total Harmonic Distortion + Noise	$P_O = 50mW$ , f = 1kHz $R_L = 16\Omega$ , single channel	0.05		%
		$P_O = 50mW$ , f = 1kHz $R_L = 32\Omega$ , single channel	0.025		
PSRR	Power Supply Rejection Ratio Full Power Mode	$V_{RIPPLE} = 200mV_{P-P}$ , input referred			
		f = 217Hz	66	56	dB
		f = 1kHz	55		
f = 20kHz	40				
SNR	Signal-to-Noise-Ratio	$R_L = 32\Omega$ , $P_{OUT} = 20mW$ , f = 1kHz, BW = 20Hz to 22kHz	100		dB
$T_{WU}$	Wake Up Time From Shutdown	Charge Pump Wake-Up Time	300		$\mu s$
$T_{WU}$	Wake Up Time	Headphone Sense Debounce Time	200		ms
$X_{TALK}$	Crosstalk	$R_L = 16\Omega$ , $P_{OUT} = 1.6mW$ , f = 1kHz, A-weighted filter	70		dB
$Z_{OUT}$	Output Impedance	In Shutdown Mode	180		k $\Omega$
$I_L$	Input Leakage		$\pm 0.1$		nA
$V_{ih}$	HPS in threshold			$0.9 \times V_{DD}$ [min]	V
$V_{il}$	HPS in threshold			$0.7 \times V_{DD}$ [max]	V

## Audio Amplifier Electrical Characteristics $V_{DD} = 3V$ (Notes 1, 2) (Continued)

The following specifications apply for  $V_{DD} = 3V$ ,  $R_L = 16\Omega$ ,  $A_V = 0dB$ , unless otherwise specified. Limits apply for  $T_A = 25^\circ C$ .

Symbol	Parameter	Conditions	LM4982		Units (Limits)
			Typical (Note 6)	Limits (Notes 7, 8)	
$R_{INT}$	Intellisense Threshold Resistance		6	3 9	$\Omega$ (min) $\Omega$ (max)

## Control Interface Electrical Characteristics (Notes 1, 2)

The following specifications apply for  $1.6V < V_{DD} < 4.0V$ , unless otherwise specified. Limits apply for  $T_A = 25^\circ C$ .

Symbol	Parameter	Conditions	LM4982		Units (Limits)
			Typical (Note 6)	Limits (Notes 7, 8)	
$t_1$	SCL period			2.5	$\mu s$ (min)
$t_2$	SDA Setup Time			100	ns (min)
$t_3$	SDA Stable Time			0	ns (min)
$t_4$	Start Condition Time			100	ns (min)
$t_5$	Stop Condition Time			100	ns (min)
$V_{IH}$				$0.7 \times I^2 C V_{DD}$	V (min)
$V_{IL}$				$0.3 \times I^2 C V_{DD}$	V (max)

**Note 1:** All voltages are measured with respect to the GND pin unless otherwise specified.

**Note 2:** Absolute Maximum Ratings indicate limits beyond which damage to the device may occur. Operating Ratings indicate conditions for which the device is functional but do not guarantee specific performance limits. Electrical Characteristics state DC and AC electrical specifications under particular test conditions which guarantee specific performance limits. This assumes that the device is within the Operating Ratings. Specifications are not guaranteed for parameters where no limit is given, however, the typical value is a good indication of device performance.

**Note 3:** The maximum power dissipation must be derated at elevated temperatures and is dictated by  $T_{JMAX}$ ,  $\theta_{JA}$ , and the ambient temperature,  $T_A$ . The maximum allowable power dissipation is  $P_{DMAX} = (T_{JMAX} - T_A) / \theta_{JA}$  or the number given in Absolute Maximum Ratings, whichever is lower. For the LM4982, see power derating currents for more information.

**Note 4:** Human body model, 100pF discharged through a 1.5k $\Omega$  resistor.

**Note 5:** Machine Model, 220pF - 240pF discharged through all pins.

**Note 6:** Typicals are measured at +25 $^\circ C$  and represent the parametric norm.

**Note 7:** Limits are guaranteed to National's AOQL (Average Outgoing Quality Level).

**Note 8:** Datasheet min/max specification limits are guaranteed by design, test, or statistical analysis.

# Typical Performance Characteristics

**THD+N vs Frequency**  
 $V_{DD} = 1.8V$ ,  $R_L = 16\Omega$ ,  
 $P_O = 7mW$ , Mono

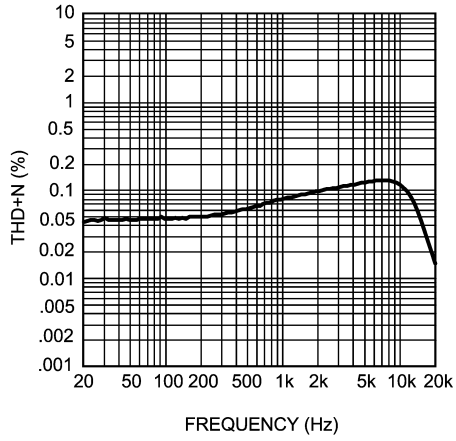

20161475

**THD+N vs Frequency**  
 $V_{DD} = 1.8V$ ,  $R_L = 16\Omega$ ,  
 $P_O = 2mW$ , Stereo

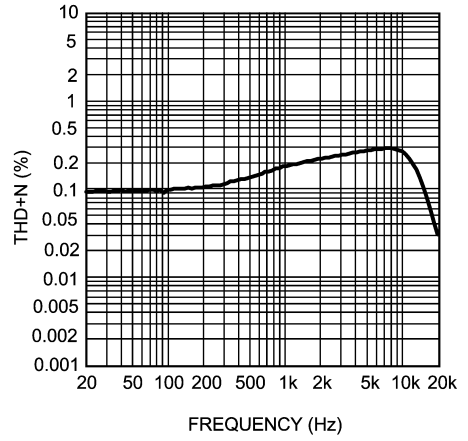

20161474

**THD+N vs Frequency**  
 $V_{DD} = 1.8V$ ,  $R_L = 32\Omega$ ,  
 $P_O = 7mW$ , Mono

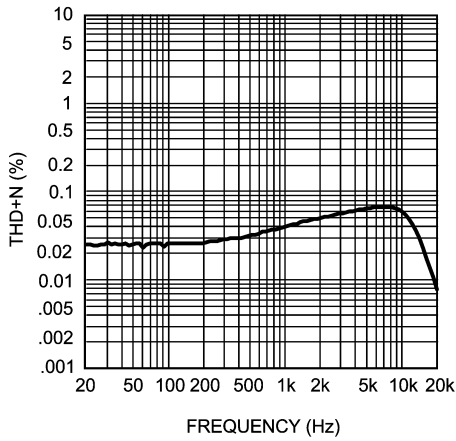

20161477

**THD+N vs Frequency**  
 $V_{DD} = 1.8V$ ,  $R_L = 32\Omega$ ,  
 $P_O = 2mW$ , Stereo

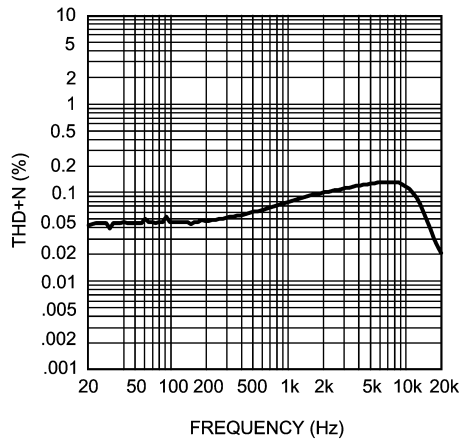

20161476

**THD+N vs Frequency**  
 $V_{DD} = 3V$ ,  $R_L = 16\Omega$ ,  
 $P_O = 50mW$ , Mono

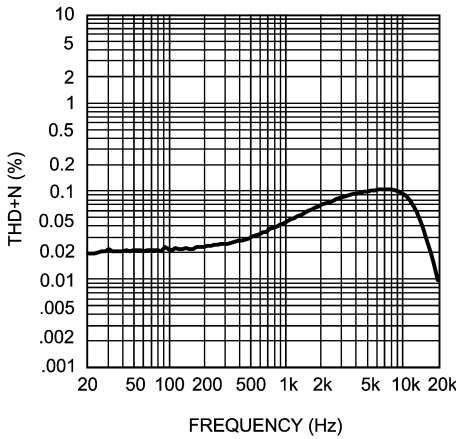

20161482

**THD+N vs Frequency**  
 $V_{DD} = 3V$ ,  $R_L = 16\Omega$ ,  
 $P_O = 25mW$ , Stereo

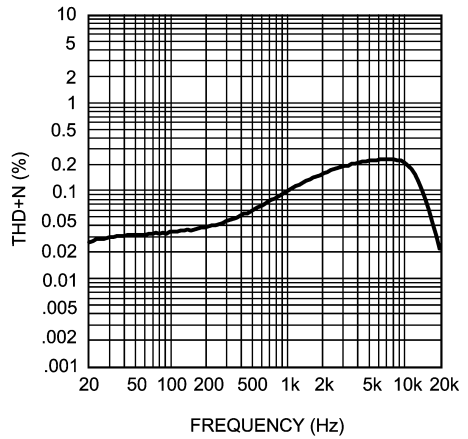

20161483

Typical Performance Characteristics (Continued)

THD+N vs Frequency

$V_{DD} = 3V, R_L = 32\Omega,$   
 $P_O = 50mW, Mono$

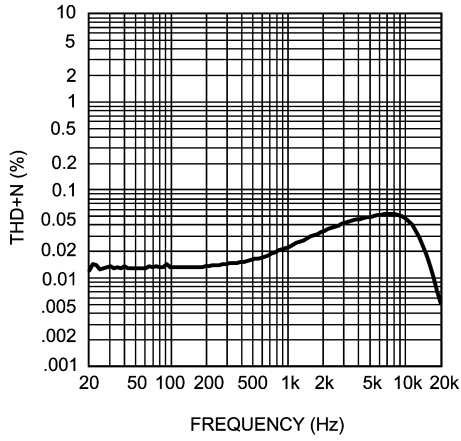

20161484

THD+N vs Frequency

$V_{DD} = 3V, R_L = 32\Omega,$   
 $P_O = 25mW, Stereo$

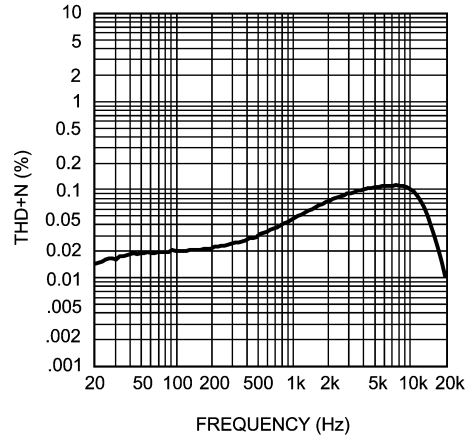

20161485

THD+N vs Frequency

$V_{DD} = 3.6V, R_L = 16\Omega,$   
 $P_O = 100mW, Mono$

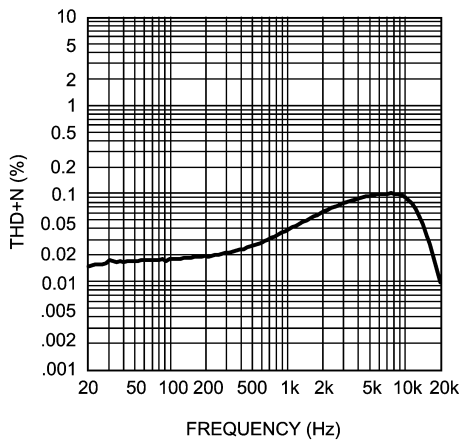

20161478

THD+N vs Frequency

$V_{DD} = 3.6V, R_L = 16\Omega,$   
 $P_O = 60mW, Stereo$

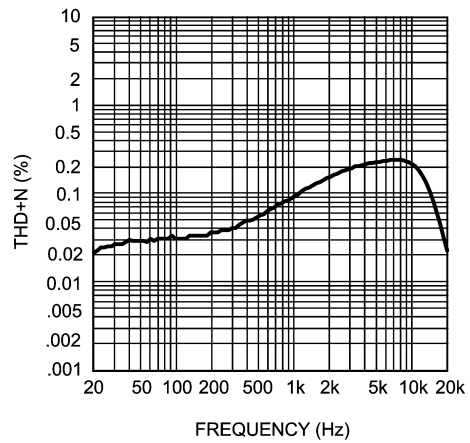

20161479

THD+N vs Frequency

$V_{DD} = 3.6V, R_L = 32\Omega,$   
 $P_O = 100mW, Mono,$

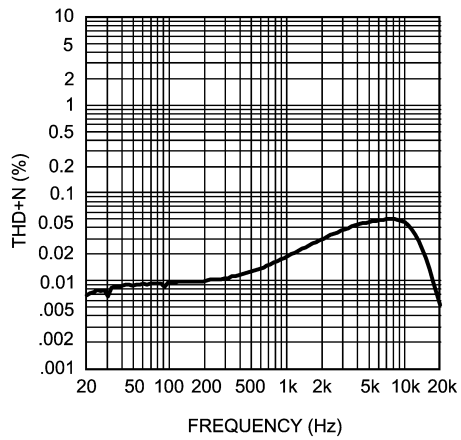

20161480

THD+N vs Frequency

$V_{DD} = 3.6V, R_L = 32\Omega,$   
 $P_O = 60mW, Stereo$

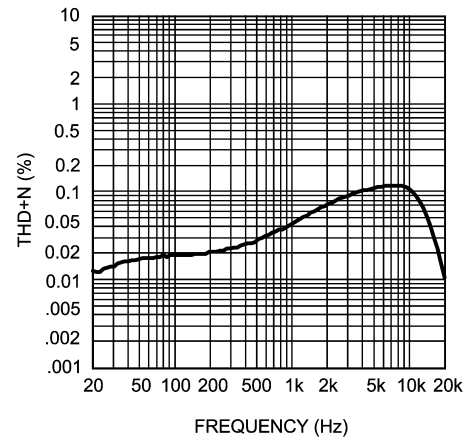

20161481

Typical Performance Characteristics (Continued)

**THD+N vs Output Power**  
 $V_{DD} = 1.8V, R_L = 16\Omega,$   
 $f = 1kHz, \text{Mono}$

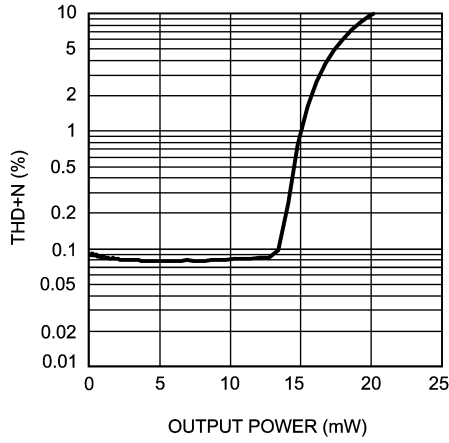

20161486

**THD+N vs Output Power**  
 $V_{DD} = 1.8V, R_L = 16\Omega,$   
 $f = 1kHz, \text{Stereo}$

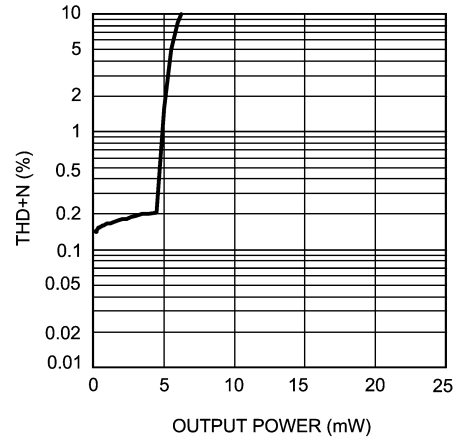

20161487

**THD+N vs Output Power**  
 $V_{DD} = 1.8V, R_L = 32\Omega,$   
 $f = 1kHz, \text{Mono}$

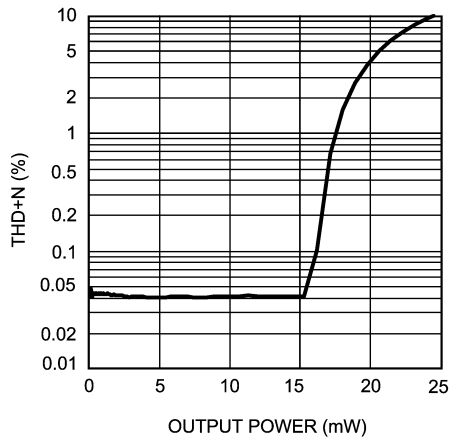

20161488

**THD+N vs Output Power**  
 $V_{DD} = 1.8V, R_L = 32\Omega,$   
 $f = 1kHz, \text{Stereo}$

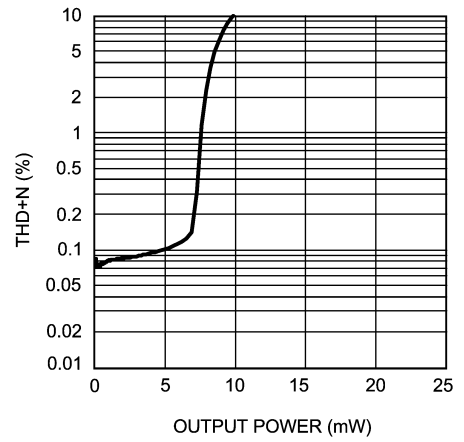

20161489

**THD+N vs Output Power**  
 $V_{DD} = 3V, R_L = 16\Omega,$   
 $f = 1kHz, \text{Mono}$

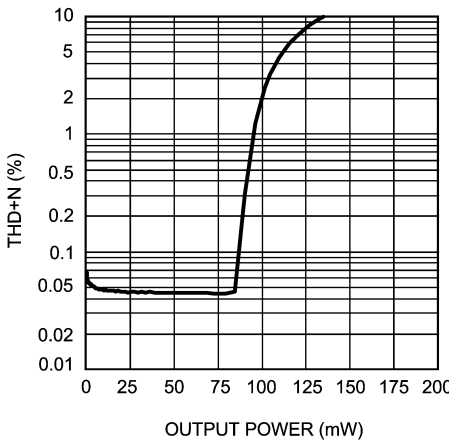

20161494

**THD+N vs Output Power**  
 $V_{DD} = 3V, R_L = 16\Omega,$   
 $f = 1kHz, \text{Stereo}$

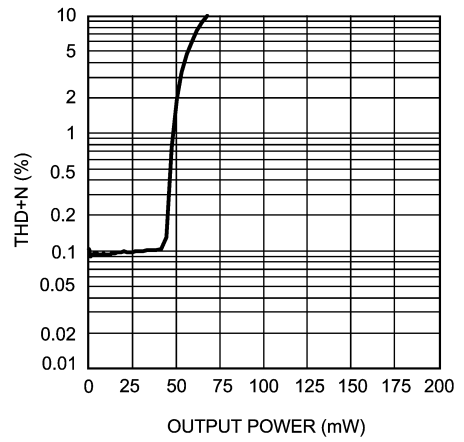

201614B2



Typical Performance Characteristics (Continued)

THD+N vs Output Power

$V_{DD} = 3V, R_L = 32\Omega,$   
 $f = 1kHz, \text{Mono}$

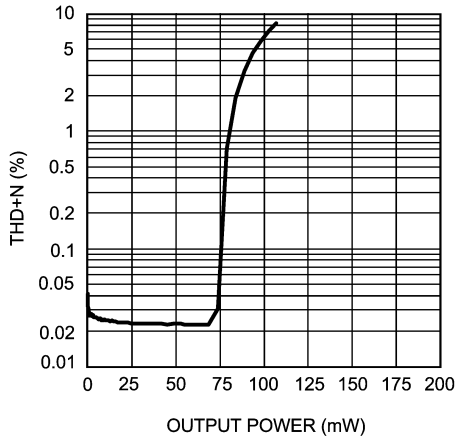

20161495

THD+N vs Output Power

$V_{DD} = 3V, R_L = 32\Omega,$   
 $f = 1kHz, \text{Stereo}$

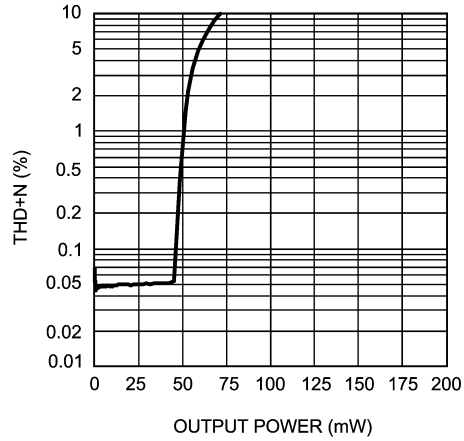

20161496

THD+N vs Output Power

$V_{DD} = 3.6V, R_L = 16\Omega,$   
 $f = 1kHz, \text{Mono}$

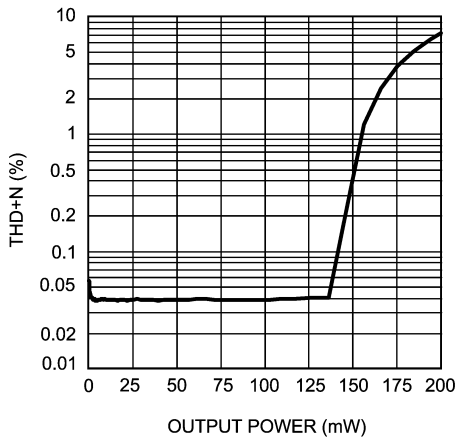

20161490

THD+N vs Output Power

$V_{DD} = 3.6V, R_L = 16\Omega,$   
 $f = 1kHz, \text{Stereo}$

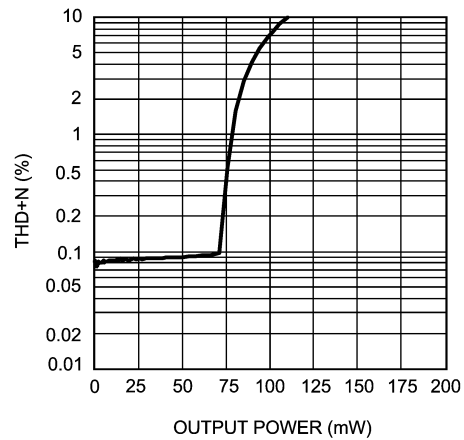

20161491

THD+N vs Output Power

$V_{DD} = 3.6V, R_L = 32\Omega,$   
 $f = 1kHz, \text{Mono}$

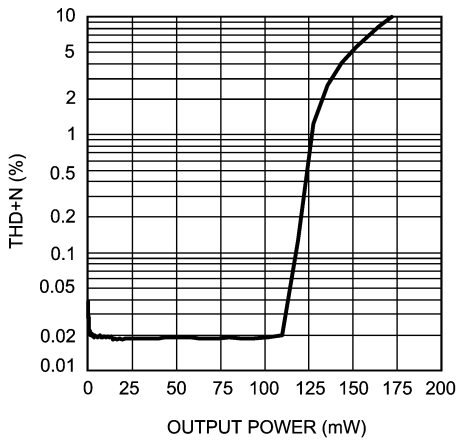

20161492

THD+N vs Output Power

$V_{DD} = 3.6V, R_L = 32\Omega,$   
 $f = 1kHz, \text{Stereo}$

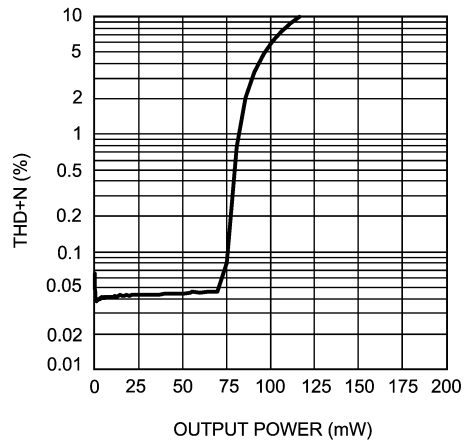

20161493

# Typical Performance Characteristics (Continued)

**Power Dissipation vs Output Power**  
 $V_{DD} = 1.8V, R_L = 16\Omega, f = 1kHz$

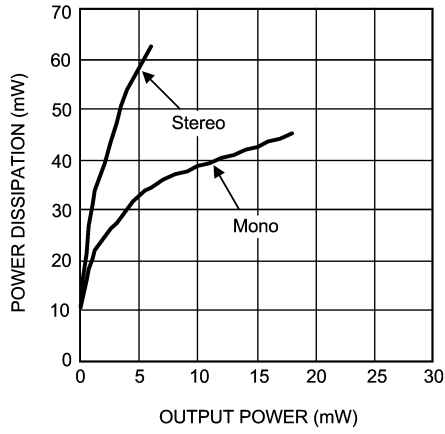

20161497

**Power Dissipation vs Output Power**  
 $V_{DD} = 1.8V, R_L = 32\Omega, f = 1kHz$

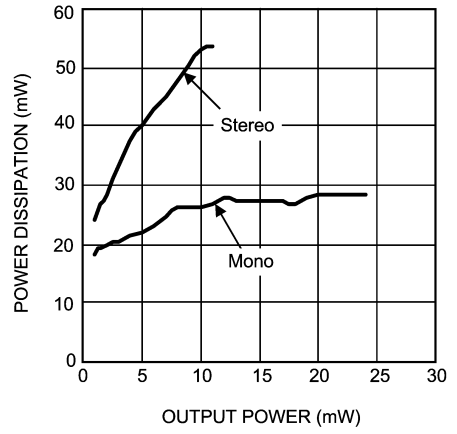

20161498

**Power Dissipation vs Output Power**  
 $V_{DD} = 3V, R_L = 16\Omega, f = 1kHz$

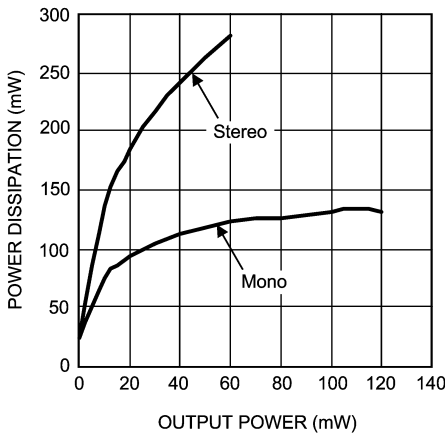

201614A4

**Power Dissipation vs Output Power**  
 $V_{DD} = 3V, R_L = 32\Omega, f = 1kHz$

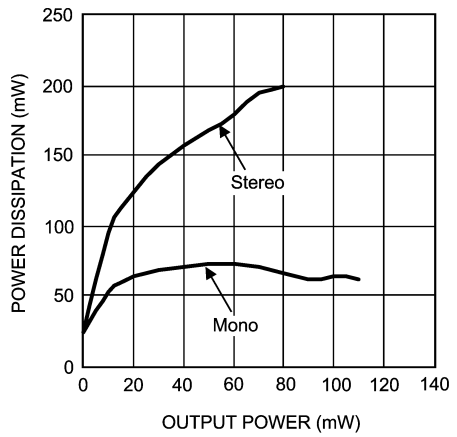

201614A5

**Power Dissipation vs Output Power**  
 $V_{DD} = 3.6V, R_L = 16\Omega, f = 1kHz$

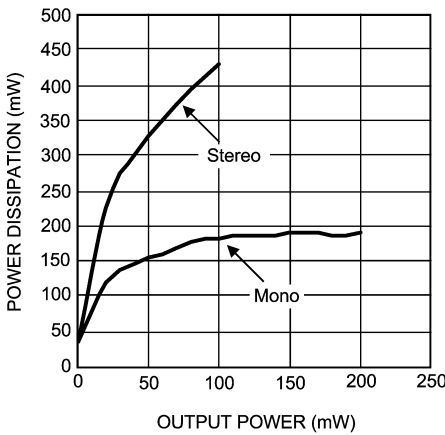

201614A2

**Power Dissipation vs Output Power**  
 $V_{DD} = 3.6V, R_L = 32\Omega, f = 1kHz$

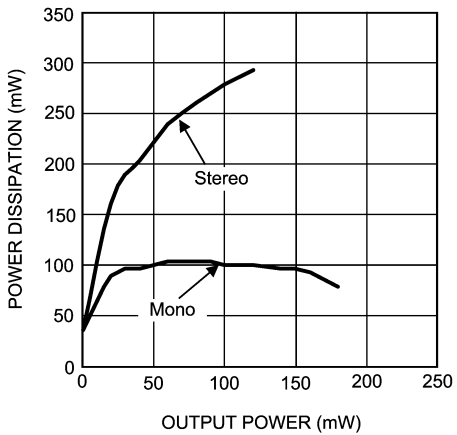

201614A3

# Typical Performance Characteristics (Continued)

**Output Power vs Power Supply Voltage**  
 $R_L = 16\Omega, f = 1\text{kHz}, \text{Mono}$

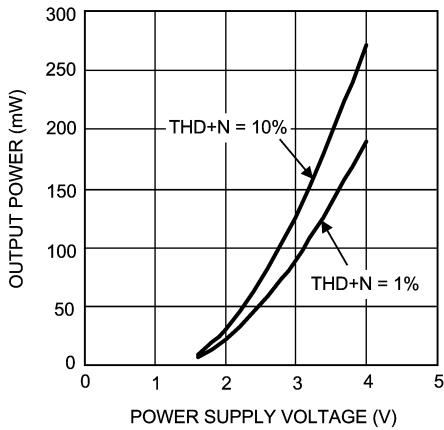

201614B5

**Output Power vs Power Supply Voltage**  
 $R_L = 16\Omega, f = 1\text{kHz}, \text{Stereo}$

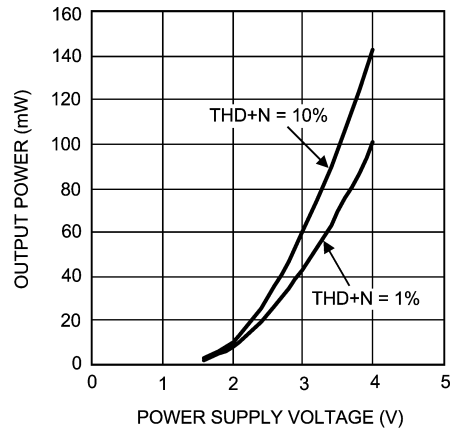

201614B6

**Output Power vs Power Supply Voltage**  
 $R_L = 32\Omega, f = 1\text{kHz}, \text{Mono}$

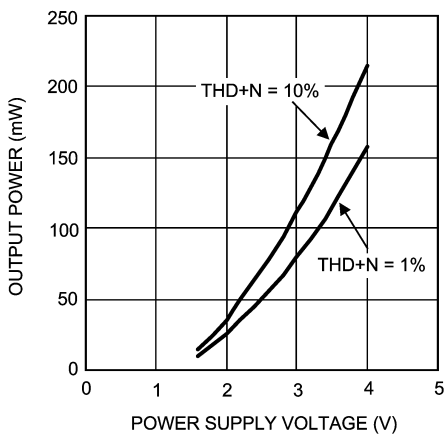

201614B7

**Output Power vs Power Supply Voltage**  
 $R_L = 32\Omega, f = 1\text{kHz}, \text{Stereo}$

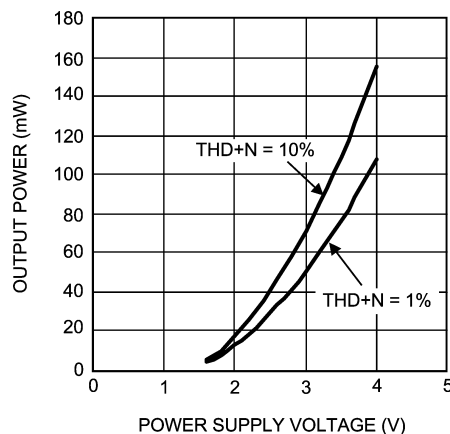

201614B8

**Power Supply Current vs Power Supply Voltage**  
 $V_{IN} = 0V, \text{Mono}$

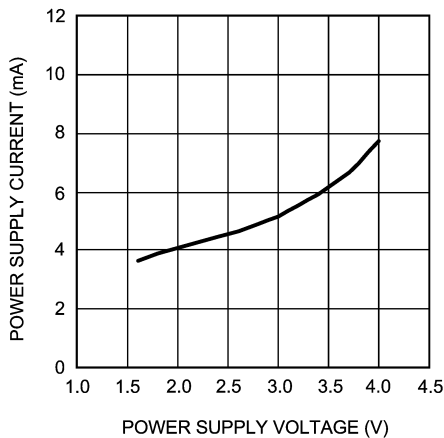

201614A6

**Power Supply Current vs Power Supply Voltage**  
 $V_{IN} = 0V, \text{Stereo}$

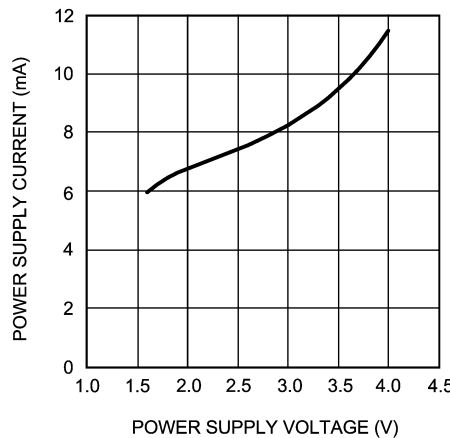

201614A7

# Typical Performance Characteristics (Continued)

**PSRR vs Frequency**  
 $V_{DD} = 1.8V$ ,  $V_{ripple} = 200mVp-p$

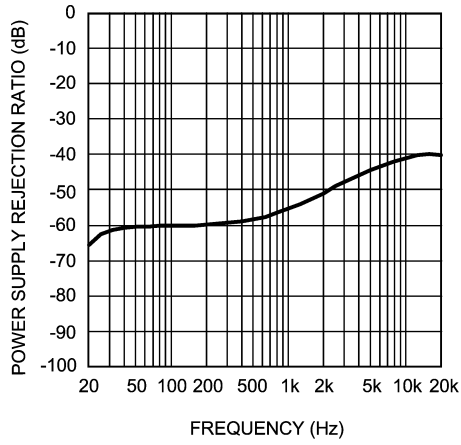

201614A8

**PSRR vs Frequency**  
 $V_{DD} = 3V$ ,  $V_{ripple} = 200mVp-p$

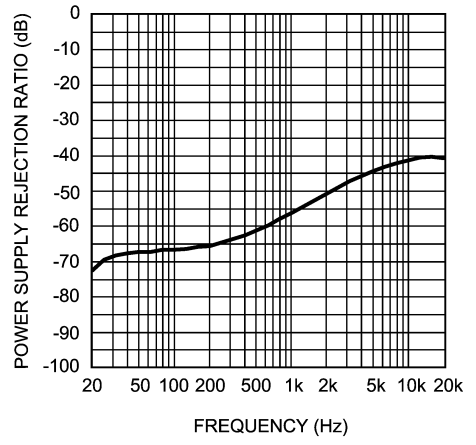

201614B1

**PSRR vs Frequency**  
 $V_{DD} = 3.6V$ ,  $V_{ripple} = 200mVp-p$

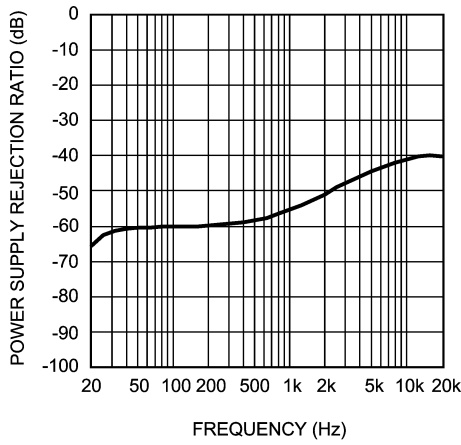

201614B0

**Crosstalk**  
 $V_{DD} = 3V$ ,  $R_L = 16\Omega$ ,  $P_O = 50mW$

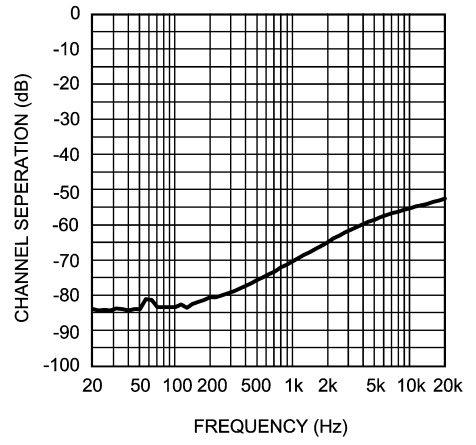

201614B3

**Crosstalk**  
 $V_{DD} = 3V$ ,  $R_L = 32\Omega$ ,  $P_O = 50mW$

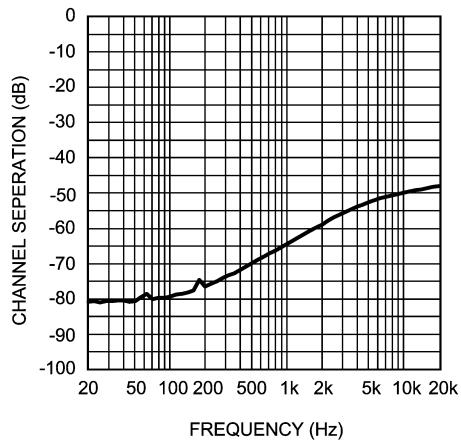

201614B4

# Application Information

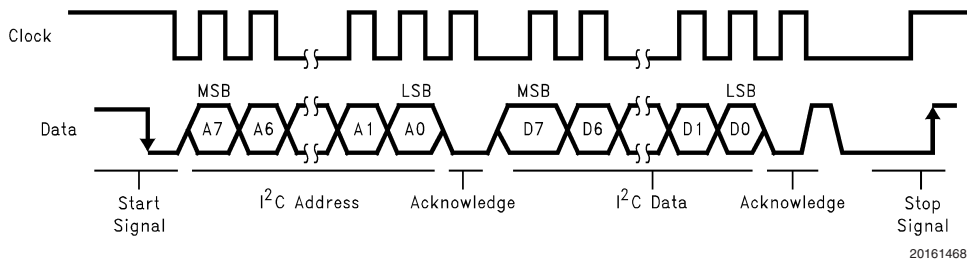

FIGURE 2. I<sup>2</sup>C Bus Format

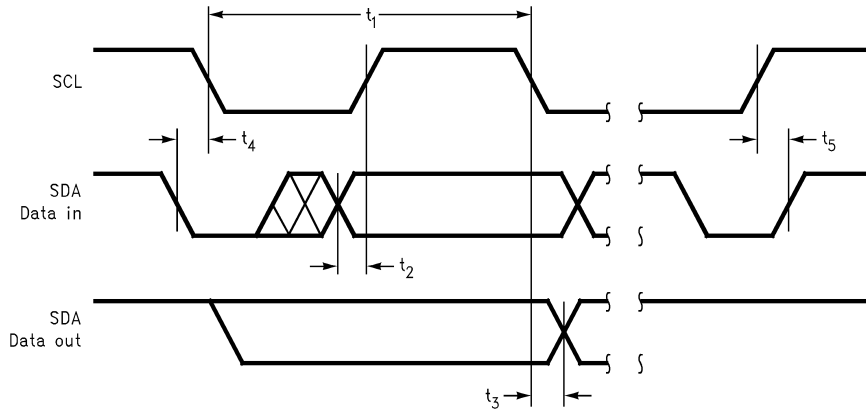

FIGURE 3. I<sup>2</sup>C Timing Diagram

TABLE 1. Chip Address

	D7	D6	D5	D4	D3	D2	D1	D0
Chip Address	1	1	1	0	1	1	0	0

TABLE 2. Control Registers

	D7	D6	D5	D4	D3	D2	D1	D0
Mode Control	0	0	0	0	CD3	CD2	CD1	CD0
Volume Control	1	0	0	VD4	VD3	VD2	VD1	VD0

TABLE 3. Mode Control

CD3	1	Intellisense Enabled
	0	Intellisense Disabled
CD2	1	Mute Enabled
	0	Mute Disabled
CD1	1	Stereo
	0	Mono *
CD0	1	Normal Operation
	0	Shutdown Enabled

\* Mono mode mixes (Left + Right) / 2, into Left output

## I<sup>2</sup>C VOLUME CONTROL

The LM4982 can be configured in 32 different gain steps by forcing I2C volume control bits to a desired gain according to the table below:

# Application Information (Continued)

**TABLE 4. Volume Control**

VD4	VD3	VD2	VD1	VD0	Gain (dB)
0	0	0	0	0	-70
0	0	0	0	1	-60
0	0	0	1	0	-52
0	0	0	1	1	-44
0	0	1	0	0	-38
0	0	1	0	1	-34
0	0	1	1	0	-30
0	0	1	1	1	-27
0	1	0	0	0	-24
0	1	0	0	1	-21
0	1	0	1	0	-18
0	1	0	1	1	-16
0	1	1	0	0	-14
0	1	1	0	1	-12
0	1	1	1	0	-10
0	1	1	1	1	-8
1	0	0	0	0	-6
1	0	0	0	1	-4
1	0	0	1	0	-2
1	0	0	1	1	0
1	0	1	0	0	2
1	0	1	0	1	4
1	0	1	1	0	6
1	0	1	1	1	8
1	1	0	0	0	10
1	1	0	0	1	12
1	1	0	1	0	13
1	1	0	1	1	14
1	1	1	0	0	15
1	1	1	0	1	16
1	1	1	1	0	17
1	1	1	1	1	18

## Application Information (Continued)

### HP SENSE FUNCTION

Connecting headphones to the headphone jack disconnects the headphone jack contact pin from OUT\_L and allows R<sub>pu</sub> to pull the HP Sense pin up to V<sub>DD</sub>. This enables the device. A microprocessor or a switch can replace the headphone jack contact pin.

Shutdown (Bit CD0)	HPS pin	Operational Mode
Logic High	Logic Low	Standby Mode
Logic High	Logic High	Full Power Mode
Logic Low	Logic Low	Micro-Power Shutdown
Logic Low	Logic High	Micro-Power Shutdown

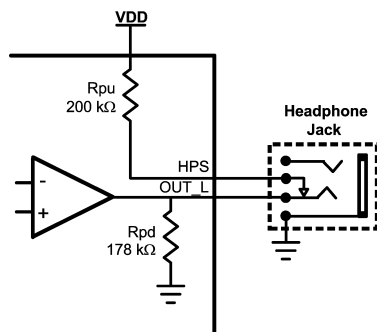

FIGURE 4.

### INTELLISENSE

National's Intellisense technology allows the LM4982 to detect whether a mono or stereo headphone has been inserted into the headphone jack. If a mono headphone is inserted into a device that is designed for a stereo headphone, one of the amplifiers will be shorted to ground. Without Intellisense, this may damage the device or, best case, the device will draw excessive current, shortening battery life.

Intellisense works by first waiting for one of the following events:

- When the device powers up, if a headphone is already inserted
- When a headphone is inserted, if the device is already powered up
- After the thermal shutdown circuitry is activated.

The occurrence of one of these events triggers the Intellisense circuitry to apply a small voltage on both left and right outputs and sense the resulting current through the load. If the load connected to the amplifier is greater than 9Ω, the amplifier driving it will be in full power mode. If the load is less than 3Ω, the LM4982 will assume a short to ground and shutdown the driving amplifier. Intellisense puts the LM4982 in mono mode when the right channel is shorted. For extra protection both amplifiers will be shutdown when the left channel is shorted to ground. The Intellisense feature can be enabled and disabled through an I2C command.

This Intellisense feature is designed for headphones with a nominal impedance of 16Ω or greater, using lower impedance loads may cause this feature to operate incorrectly.

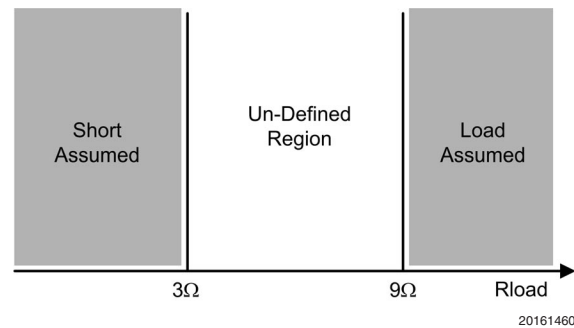

FIGURE 5.

### MONO/STEREO OPERATION

When Intellisense is disabled the value of the CD1 bit of the mode control determines if the LM4982 is in mono or stereo mode. When the LM4982 is in mono mode the left and right input signals are mixed to the left channel amplifier and attenuated by -6dB. The right channel amplifier is put in shutdown to save power. The mixing function allows full reproduction of a stereo input signal in a mono headphone and optimum headroom is kept by attenuating by a factor of two.

### I<sup>2</sup>C COMPATIBLE INTERFACE

The LM4982 uses a serial bus, which conforms to the I<sup>2</sup>C protocol, to control the chip's functions with two wires: clock (SCL) and data (SDA). The clock line is uni-directional. The data line is bi-directional (open-collector). The maximum clock frequency specified by the I<sup>2</sup>C standard is 400kHz. In this discussion, the master is the controlling microcontroller and the slave is the LM4982.

The bus format for the I<sup>2</sup>C interface is shown in Figure 2. The bus format diagram is broken up into six major sections:

The "start" signal is generated by lowering the data signal while the clock signal is high. The start signal will alert all devices attached to the I<sup>2</sup>C bus to check the incoming address against their own address.

The 8-bit chip address is sent next, most significant bit first. The data is latched in on the rising edge of the clock. Each address bit must be stable while the clock level is high.

After the last bit of the address bit is sent, the master releases the data line high (through a pull-up resistor). Then the master sends an acknowledge clock pulse. If the LM4982 has received the address correctly, then it holds the data line low during the clock pulse. If the data line is not held low during the acknowledge clock pulse, then the master should abort the rest of the data transfer to the LM4982.

The 8 bits of data are sent next, most significant bit first. Each data bit should be valid while the clock level is stable high.

After the data byte is sent, the master must check for another acknowledge to see if the LM4982 received the data.

If the master has more data bytes to send to the LM4982, then the master can repeat the previous two steps until all data bytes have been sent.

The "stop" signal ends the transfer. To signal "stop", the data signal goes high while the clock signal is high. The data line should be held high when not in use.

## Application Information (Continued)

### I<sup>2</sup>C INTERFACE POWER SUPPLY PIN (I<sup>2</sup>CV<sub>DD</sub>)

The LM4982's I<sup>2</sup>C interface is powered up through the I<sup>2</sup>CV<sub>DD</sub> pin. The LM4982's I<sup>2</sup>C interface operates at a voltage level set by the I<sup>2</sup>CV<sub>DD</sub> pin which can be set independent to that of the main power supply pin V<sub>DD</sub>. This is ideal whenever logic levels for the I<sup>2</sup>C interface are dictated by a microcontroller or microprocessor that is operating at a lower supply voltage than the main battery of a portable system.

### POWER SUPPLY BYPASSING

As with any power amplifier, proper supply bypassing is critical for low noise performance and high power supply rejection. Applications that employ a 5V regulator typically use a 10μF in parallel with a 0.1μF filter capacitors to stabilize the regulator's output, reduce noise on the supply line, and improve the supply's transient response. However, their presence does not eliminate the need for a local 1.0μF tantalum bypass capacitance connected between the LM4982's supply pins and ground. Keep the length of leads and traces that connect capacitors between the LM4982's power supply pins and ground as short as possible.

### ELIMINATING THE OUTPUT COUPLING CAPACITOR

The LM4982 features a low noise inverting charge pump that generates an internal negative supply voltage. This allows the outputs of the LM4982 to be biased about GND instead of a nominal DC voltage, like traditional headphone amplifiers. Because there is no DC component, the large DC blocking capacitors (typically 220μF) are not necessary. The coupling capacitors are replaced by two, small ceramic charge pump capacitors, saving board space and cost.

Eliminating the output coupling capacitors also improves low frequency response. In traditional headphone amplifiers, the headphone impedance and the output capacitor form a high pass filter that not only blocks the DC component of the output, but also attenuates low frequencies, impacting the bass response. Because the LM4982 does not require the output coupling capacitors, the low frequency response of the device is not degraded by external components.

In addition to eliminating the output coupling capacitors, the ground referenced output nearly doubles the available dynamic range of the LM4982 when compared to a traditional headphone amplifier operating from the same supply voltage.

### OUTPUT TRANSIENT ('CLICK AND POPS') ELIMINATED

The LM4982 contains advanced circuitry that virtually eliminates output transients ('clicks and pops'). This circuitry prevents all traces of transients when the supply voltage is first applied or when the part resumes operation after coming out of shutdown mode.

### POWER DISSIPATION

Power dissipation is a major concern when using any power amplifier and must be thoroughly understood to ensure a successful design. Equation 1 states the maximum power dissipation point for a single-ended amplifier operating at a given supply voltage and driving a specified output load.

$$P_{\text{DMAX}} = (2V_{\text{DD}})^2 / (2\pi^2 R_L) \quad (1)$$

Since the LM4982 has two operational amplifiers in one package, the maximum internal power dissipation point is twice that of the number which results from Equation 1. Even with large internal power dissipation, the LM4982 does not require heat sinking over a large range of ambient temperatures. The maximum power dissipation point obtained must not be greater than the power dissipation that results from Equation 2:

$$P_{\text{DMAX}} = (T_{\text{JMAX}} - T_A) / (\theta_{\text{JA}}) \quad (2)$$

For the micro SMD package,  $\theta_{\text{JA}} = 105^\circ\text{C/W}$ .  $T_{\text{JMAX}} = 150^\circ\text{C}$  for the LM4982. Depending on the ambient temperature,  $T_A$ , of the system surroundings, Equation 2 can be used to find the maximum internal power dissipation supported by the IC packaging. If the result of Equation 1 is greater than that of Equation 2, then either the supply voltage must be decreased, the load impedance increased or  $T_A$  reduced. Power dissipation is a function of output power and thus, if typical operation is not around the maximum power dissipation point, the ambient temperature may be increased accordingly.

### SELECTING PROPER EXTERNAL COMPONENTS

Optimizing the LM4982's performance requires properly selecting external components. Though the LM4982 operates well when using external components with wide tolerances, best performance is achieved by optimizing component values.

#### Charge Pump Capacitor Selection

Use low ESR (equivalent series resistance) (<100mΩ) ceramic capacitors with an X7R dielectric for best performance. Low ESR capacitors keep the charge pump output impedance to a minimum, extending the headroom on the negative supply. Higher ESR capacitors result in reduced output power from the audio amplifiers.

Charge pump load regulation and output impedance are affected by the value of the flying capacitor (C1). A larger valued C1 (up to 3.3μF) improves load regulation and minimizes charge pump output resistance. Beyond 3.3μF, the switch-on resistance dominates the output impedance for capacitor values above 2.2μF.

The output ripple is affected by the value and ESR of the output capacitor (C2). Larger capacitors reduce output ripple on the negative power supply. Lower ESR capacitors minimize the output ripple and reduce the output impedance of the charge pump.

The LM4982 charge pump design is optimized for 2.2μF, low ESR, ceramic, flying, and output capacitors.

#### Input Capacitor Value Selection

Amplifying the lowest audio frequencies requires high value input coupling capacitors (C<sub>i</sub> in Figure 1). A high value capacitor can be expensive and may compromise space efficiency in portable designs. In many cases, however, the speakers used in portable systems, whether internal or external, have little ability to reproduce signals below 150Hz. Applications using speakers with this limited frequency response reap little improvement by using high value input and output capacitors.

Besides affecting system cost and size, C<sub>i</sub> has an effect on the LM4982's click and pop performance. The magnitude of the pop is directly proportional to the input capacitor's size.



## Application Information (Continued)

Thus, pops can be minimized by selecting an input capacitor value that is no higher than necessary to meet the desired -3dB frequency.

As shown in Figure 1, the internal input resistor,  $R_i$  and the input capacitor,  $C_i$ , produce a -3dB high pass filter cutoff frequency that is found using Equation (3). Conventional headphone amplifiers require output capacitors; Equation (3) can be used, along with the value of  $R_L$ , to determine towards the value of output capacitor needed to produce a -3dB high pass filter cutoff frequency.

$$f_{i-3dB} = 1 / 2\pi R_i C_i \quad (3)$$

Also, careful consideration must be taken in selecting a certain type of capacitor to be used in the system. Different types of capacitors (tantalum, electrolytic, ceramic) have unique performance characteristics and may affect overall system performance. (See the section entitled Charge Pump Capacitor Selection.)

# Demo Board Artwork

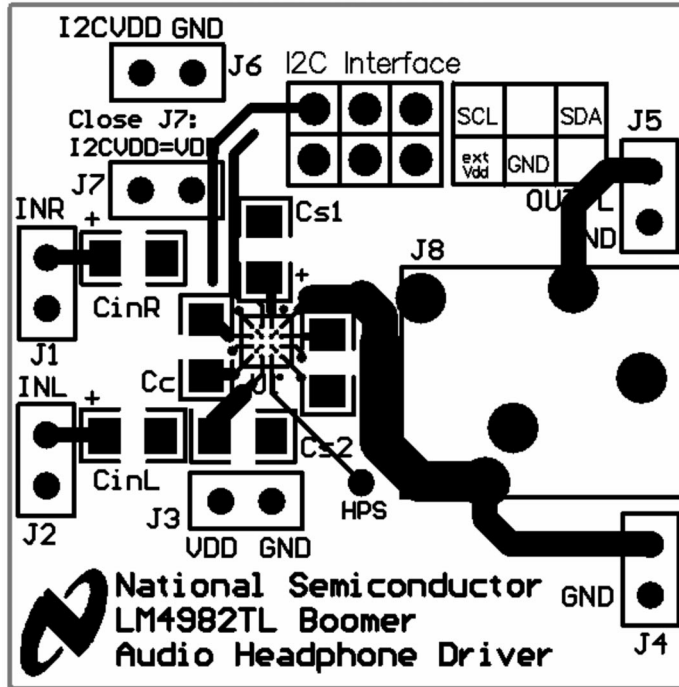

201614A0

Top Layer

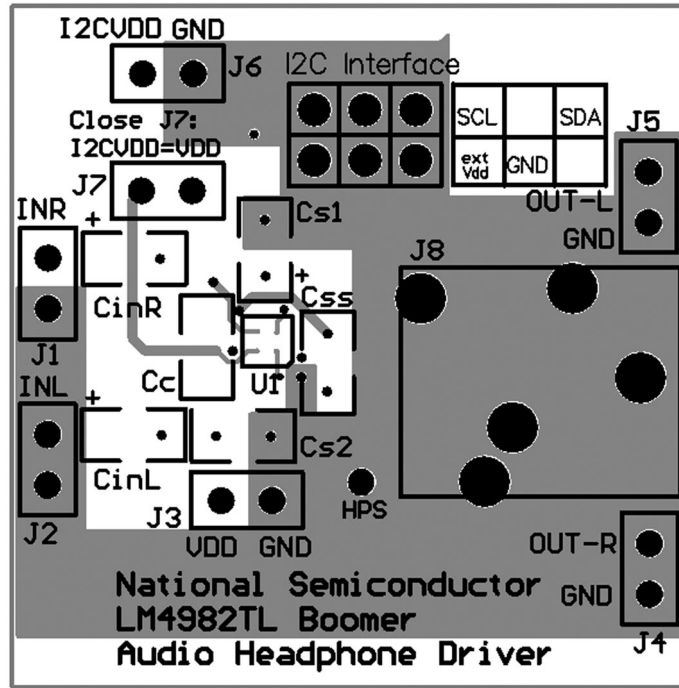

20161470

Mid Layer 1

Demo Board Artwork (Continued)

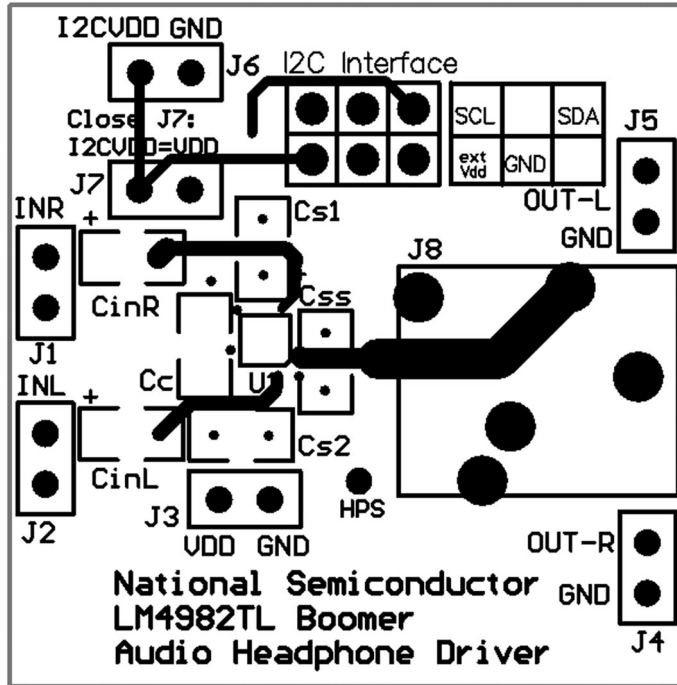

20161471

Mid Layer 2

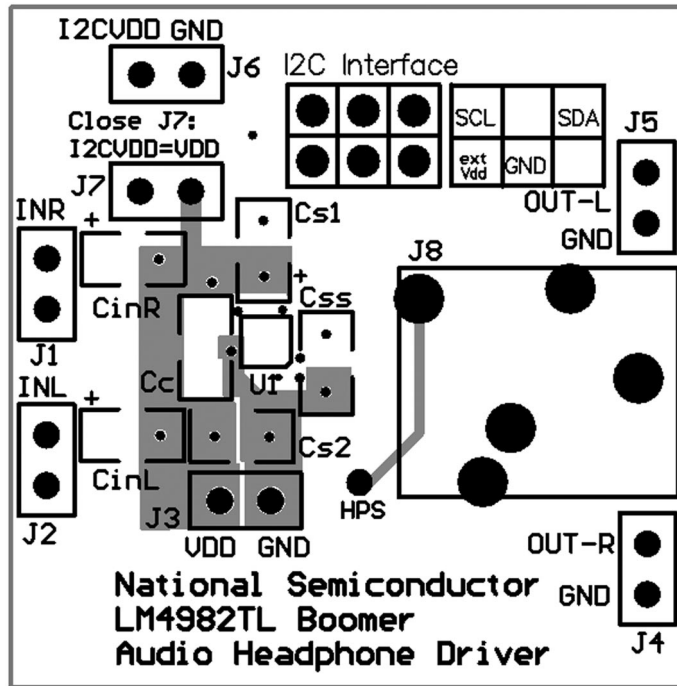

20161469

Bottom Layer

**Revision History**

Rev	Date	Description
1.0	2/09/06	Initial WEB release.
1.1	7/27/06	Edited the mktg outline descriptions (X1, X2, and X3), then re-released the D/S to the WEB per Nisha P.

**Physical Dimensions** inches (millimeters) unless otherwise noted

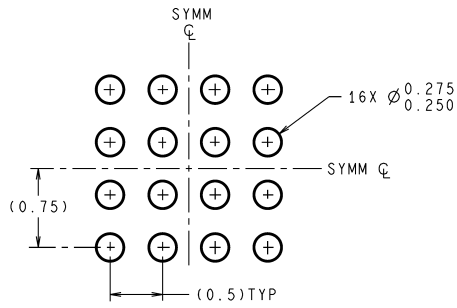

**DIMENSIONS ARE IN MILLIMETERS**  
DIMENSIONS IN ( ) FOR REFERENCE ONLY

**LAND PATTERN RECOMMENDATION**

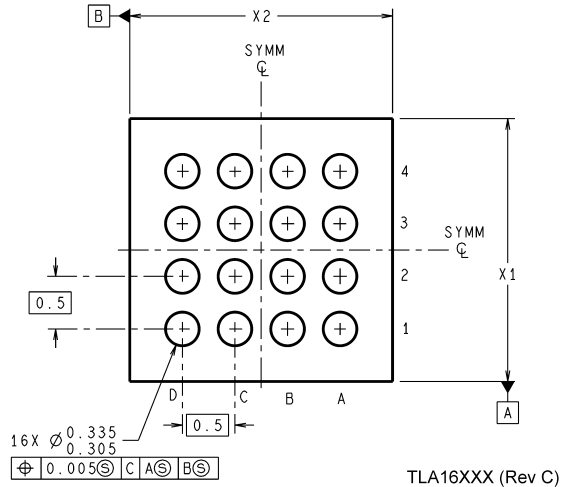
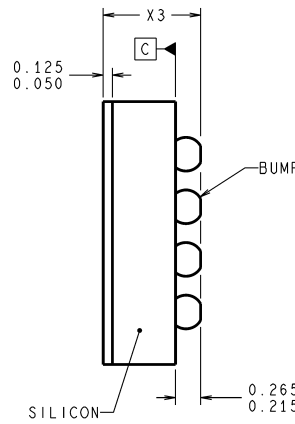
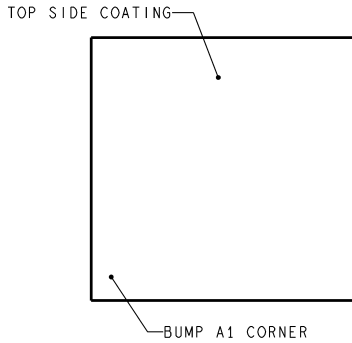

TLA16XXX (Rev C)

**16-Bump micro SMD**  
**Order Number LM4982TL**  
**NS Package Number TLA1611A**  
 **$X_1 = 1.965 \pm 0.03$   $X_2 = 1.965 \pm 0.03$   $X_3 = 0.6 \pm 0.075$**

National does not assume any responsibility for use of any circuitry described, no circuit patent licenses are implied and National reserves the right at any time without notice to change said circuitry and specifications.

For the most current product information visit us at [www.national.com](http://www.national.com).

**LIFE SUPPORT POLICY**

NATIONAL'S PRODUCTS ARE NOT AUTHORIZED FOR USE AS CRITICAL COMPONENTS IN LIFE SUPPORT DEVICES OR SYSTEMS WITHOUT THE EXPRESS WRITTEN APPROVAL OF THE PRESIDENT AND GENERAL COUNSEL OF NATIONAL SEMICONDUCTOR CORPORATION. As used herein:

1. Life support devices or systems are devices or systems which, (a) are intended for surgical implant into the body, or (b) support or sustain life, and whose failure to perform when properly used in accordance with instructions for use provided in the labeling, can be reasonably expected to result in a significant injury to the user.
2. A critical component is any component of a life support device or system whose failure to perform can be reasonably expected to cause the failure of the life support device or system, or to affect its safety or effectiveness.

**BANNED SUBSTANCE COMPLIANCE**

National Semiconductor follows the provisions of the Product Stewardship Guide for Customers (CSP-9-111C2) and Banned Substances and Materials of Interest Specification (CSP-9-111S2) for regulatory environmental compliance. Details may be found at: [www.national.com/quality/green](http://www.national.com/quality/green).

Lead free products are RoHS compliant.



**National Semiconductor**  
**Americas Customer Support Center**  
Email: [new.feedback@nsc.com](mailto:new.feedback@nsc.com)  
Tel: 1-800-272-9959

**National Semiconductor**  
**Europe Customer Support Center**  
Fax: +49 (0) 180-530 85 86  
Email: [europe.support@nsc.com](mailto:europe.support@nsc.com)  
Deutsch Tel: +49 (0) 69 9508 6208  
English Tel: +44 (0) 870 24 0 2171  
Français Tel: +33 (0) 1 41 91 8790

**National Semiconductor**  
**Asia Pacific Customer Support Center**  
Email: [ap.support@nsc.com](mailto:ap.support@nsc.com)

**National Semiconductor**  
**Japan Customer Support Center**  
Fax: 81-3-5639-7507  
Email: [jpn.feedback@nsc.com](mailto:jpn.feedback@nsc.com)  
Tel: 81-3-5639-7560